

Safety module SMSA31



For safety gates, magnetic switches, safety limit switches in anti-valent mode



Main features

- **Multiple types inputs.** The safety module can monitor the safety state of emergency gates equipped with safety non-contact or electromechanical limit switches in anti-valent operating mode
- **Machinery Directive compliance.** Cat. 4, PL e in accordance with EN ISO 13849-1
- **Multiple operating modes.** The device can operate with automatic, manual or monitored manual start/reset
- **Safety outputs.** Electromechanical forcibly guided safety relays with 3NO+1NC aux outputs
- **Flexible wiring.** The module is equipped with detachable screw terminals for easy wiring and product maintenance; the terminal blocks are coded so to avoid wiring mistakes
- **Diagnostic.** LED indications for power supply, state of the safety inputs and state of the safety outputs
- **Compact.** 1-DIN, WxHxD: 17,5x110,8x121,1mm
- **Approval** by TÜV. CE, cULus

Description

The SMSA31 safety module is designed in Category 4, Performance Level e in accordance with the Machine Directive EN ISO 13849-1 to monitor and control safely the safety circuits in safety gates with safety magnetic switches and safety limit switches switching the safety inputs in anti-valent mode (NO+NC signals). The module can monitor and control single or multiple safety accesses with cascade of safety switches.

Main functions

- Monitoring of safety circuits in applications with safety gates equipped with safety magnetic or electromechanical safety switches operating the input signals in anti-valent mode
- Double safety channels operation; the device monitors the change of state of the two safety inputs that operate in anti-valent mode (channel-1 NO and channel-2 NC)
- Monitoring of single or multiple safety gates in cascade
- Control of up to 3 NO safety outputs with electromechanical safety relays
- Selectable start/reset operating mode Manual, Automatic or Monitored Manual Start
- Diagnostic of the safety circuit through on-board LED indications for power supply, status of safety channels and status of safety outputs
- 1 NC auxiliary output that can be used for external status indication





References

Order code

NO safety outputs	Aux NC output	Ordering code
3	1	SMSA31

Further reading

Information	Where to find it	QR
Instruction manual	http://www.productselection.net/MANUALS/UK/SM_IM.pdf	
SISTEMA Libraries	http://www.gavazzi-automation.com/nsc/HQ/EN/safety_modules	



COPYRIGHT ©2019
 Content subject to change. Download the PDF: www.productselection.net

Structure

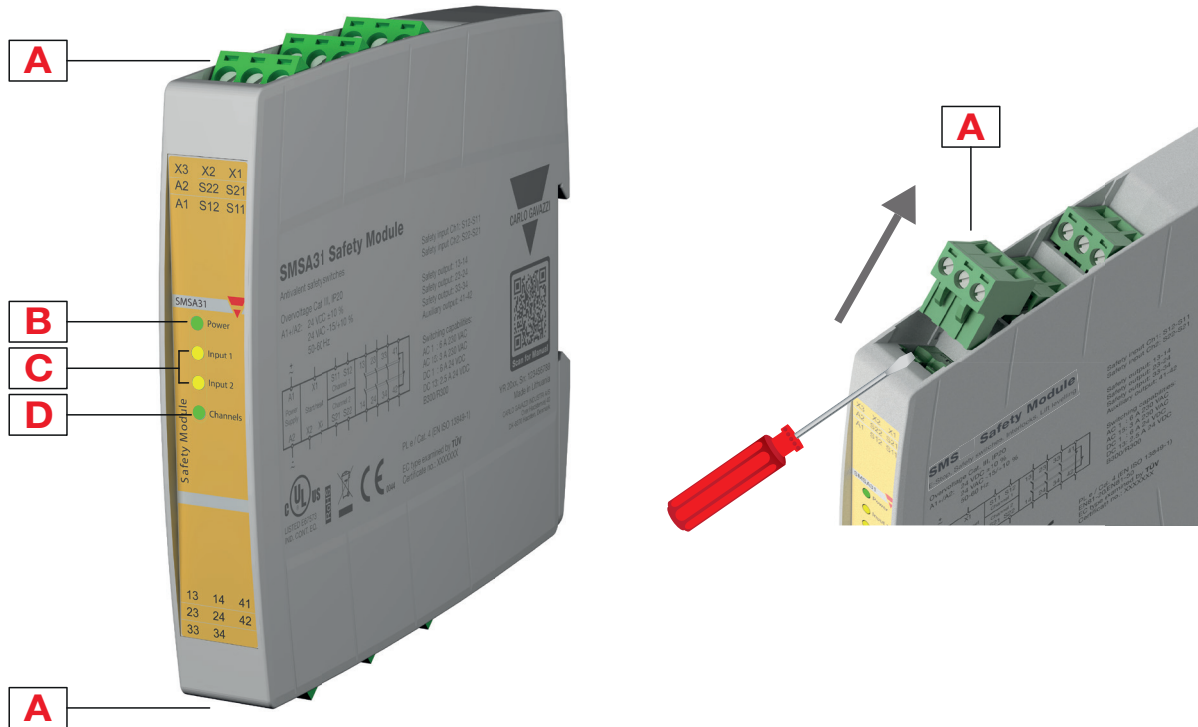

Element	Component	Function
A	Pluggable terminal blocks	Power supply, start signal, safety inputs and outputs
B	LED	Power supply status
C	LED	Safety inputs status
D	LED	Safety outputs status

Features

General

Material	PA-GF, self-extinguishing: UL 94 V-0
Weight	239g
Assembly	DIN rail mounting (According to EN 50022)

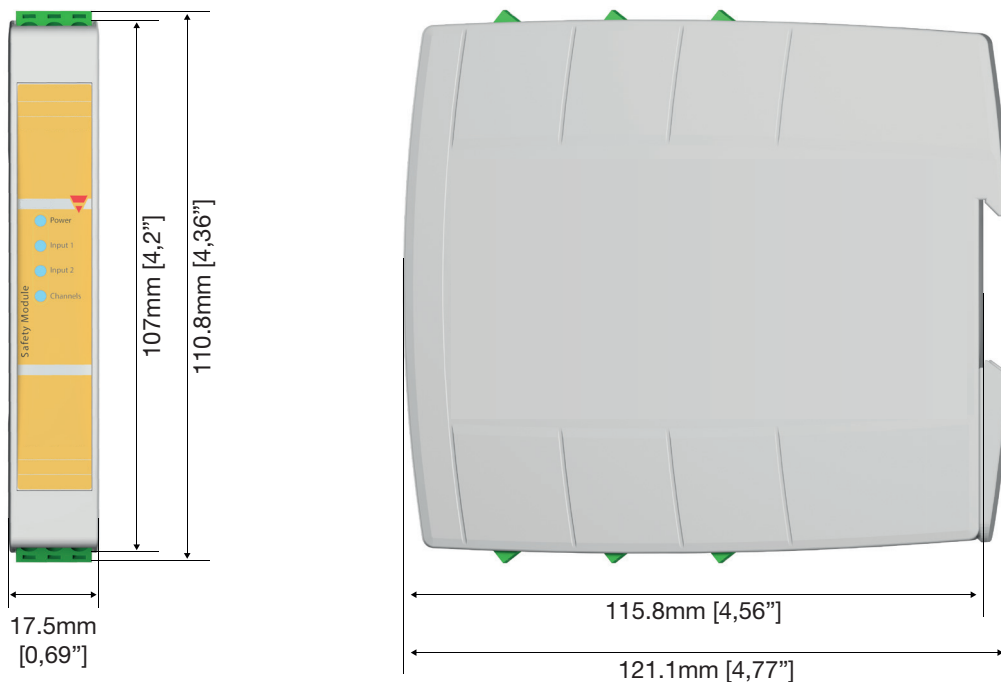

Power Supply

Power supply	24Vdc \pm 10%; 24Vac -15%/+10%, 50÷60 Hz, Class 2
	Overvoltage category III/II
	Short circuit protection internal PTC
	Rated insulation voltage 4 kV

Inputs

Number of safety channels	2
Safety inputs (contact inputs)	S11-S12 and S21-S22
Loop resistance	Max. 1 k Ω
Input voltage (acc. to EN61131)	0 - 35 VDC
Input current	Typical 5 mA





Outputs

NO safety outputs	3
NC auxiliary output	1
Type	Voltage free contact output, relays with forcibly guided contacts
Max current rating - single output	@ 60°C (140°F) operating temperature: AC 1: 250V / 6A / 2000 VA - AC 15: 230V / 3A DC 1: 24V / 6A - DC 13: 24V / 2.5A / 0.1 Hz UL508, pilot duty: B300 / R300
Max quadratic current	Spacing between modules ≥100mm: 72A ² @40°C (104°F) ambient temperature Modules mounted stacked: 26A ² @25°C (77°F) ambient temperature Please refer to the derating curves in installation manual
Mechanical life	> 10 ⁷ operations
Electrical life AC1 (360 s/h)	~ 10 ⁵ operations

Safety parameters

ISO 13849-1 Safety Category	Cat. 4
ISO 13849-1 Performance Level	PL e
MTTF_d [a]	420,8
PFH_d [1/h]	1,85 E-10
DCavg	99%
β	5,00 E-02
β_d	2,00 E-02

Compatibility and conformity

Low Voltage Directive 2014/35/EU	EN 60947-5-1: 2004 Low-voltage switchgear and controlgear - Control circuit devices and switching elements - Electromechanical control circuit devices
EMC Directive 2014/30/EU	EN 60947-5-1: 2004 Low-voltage switchgear and controlgear - Control circuit devices and switching elements - Electromechanical control circuit devices
Machinery Directive 2006/42/EC EC type examined by TÜV Cert. no. 44 205 15058307	EN ISO 13849-1: 2015 Safety of machinery - safety related parts of control systems - General principles for design EN60204-1: 2006 Safety of machinery - Electrical equipment of machines - General requirements EN 61326-3-1: 2017 Electrical equipment for measurement, control and laboratory use. EMC requirements. Immunity requirements for safety-related systems and for equipment intended to perform safety-related functions (functional safety) - General industrial applications
Approvals	  



Environmental

Protection grade	IP40 on frontal part of the housing, IP20 on the terminals. The device has to be installed in a cabinet with protection degree of IP54.
Pollution degree	2
Operating Temperature	-25 ÷ +60°C (-13 ÷ 140°F), UL: +40°C (104°F)
Storage Temperature	-30 ÷ +70°C (-22 ÷ 158°F)
Ambient humidity range	R.H. ≤95% non condensing

Connection Diagrams

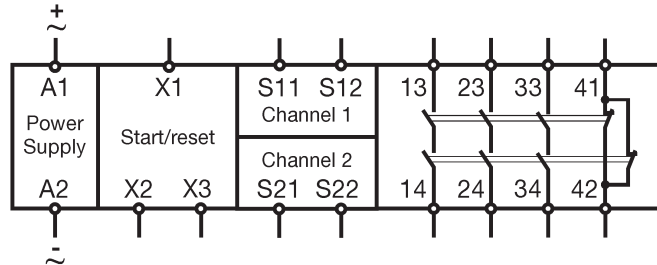

Terminal	Function
A1	power supply 24 Vdc (+)/Vac(~)
A2	power supply 24 Vdc (-)/Vac(~)
S11-S12	channel 1 NO input
S21-S22	channel 2 NC input
X1-X2	manual start / automatic start
X1-X3	monitored manual start
13-14	NO safety output
23-24	NO safety output
33-34	NO safety output
41-42	NC auxiliary output

Double channel mode

